

Ashland[®]



pre-lit tree

INSTRUCTIONS GUIDE

attention

Class B Disclaimer: This equipment has been tested and found to comply with the limits for a Class B digital device, pursuant to Part 15 of the FCC Rules. These limits are designed to provide reasonable protection against harmful interference in a residential installation. This equipment generates, uses and can radiate radio frequency energy and, if not installed and used in accordance with the instructions, may cause harmful interference to radio communications. However, there is no guarantee that interference will not occur in a particular installation. If this equipment does cause harmful interference to radio or television reception, which can be determined by turning the equipment off and on, the user is encouraged to try to correct the interference by one or more of the following measures:

- Reorient or relocate the receiving antenna.
- Increase the separation between the equipment and receiver.
- Connect the equipment into an outlet on a circuit different from that to which the receiver is connected.
- Consult the dealer or an experienced radio/television technician for help.

Please note that changes or modifications of this product not expressly approved by the party responsible for compliance could void the user's authority to operate the equipment.

READ AND FOLLOW ALL THE SAFETY INSTRUCTIONS.

This decorative item is not intended for use by persons (including children) with reduced physical, sensory or mental capabilities, or lack of experience and knowledge, unless they have been giving supervision.

Children should be monitored to ensure that the items are not used as toys.

CAUTION and essentially the following: To reduce the risk of fire and electric shock.

Disconnect the power supply from the decorative item before carrying out any maintenance or cleaning activities.

Do not use the decorative item outdoors.

Do not install or place near gas or electric heaters, fireplaces, candles or other similar sources of heat.

Disconnect the appliance when leaving the house, when retiring or if left unattended.

Do not hang ornaments or other objects to the cord, cable or series of lights.

Do not cover the decorative item with a cloth, paper or any material that is not part of the product when it is in use.

Do not install the string lights so that the insulation of the cable can be cut or damaged.

WARNING!

This product may potentially trigger seizures for people with photosensitive epilepsy when using the motion effect light modes.

Do not connect the chain to the supply while it is in the packing.

The connecting cable cannot be repaired or replaced. If the cable is damaged the entire fitting must be discarded.

NON-REPLACEABLE BULB.

Do not connect this chain electrically to devices from another manufacturer.

 CAUTION! For indoor use only.

 The crossed-out wheeled bin symbol indicates that the item should be disposed of separately from household waste. The item should be handed in for recycling in accordance with local environmental regulations for waste disposal.

Technical Specifications

Power supply: see label

Single LED luminous flux: red 600 mcd, green 1500 mcd, blue 500 mcd

physical set up

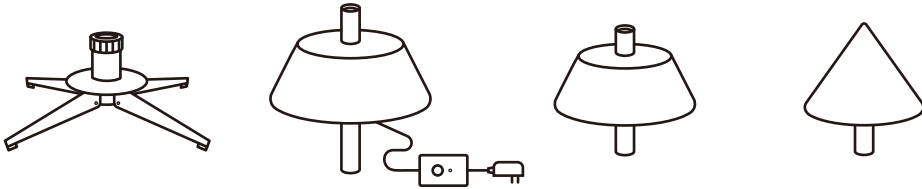

a.

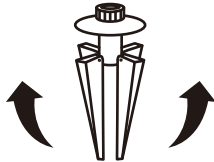

b.

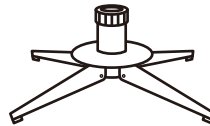
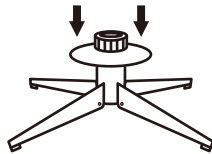

c.

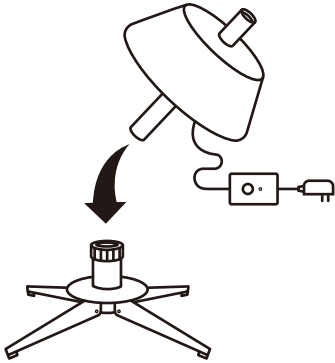

d.

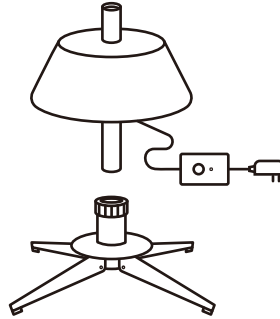

e.

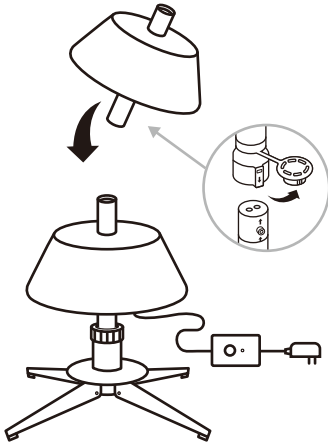

f.

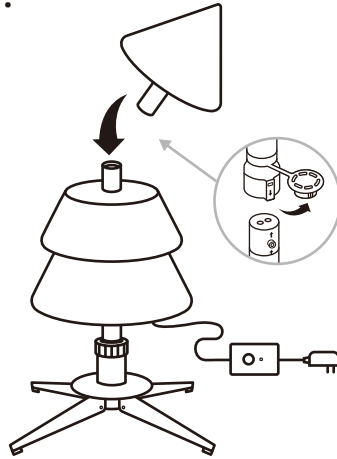

1.

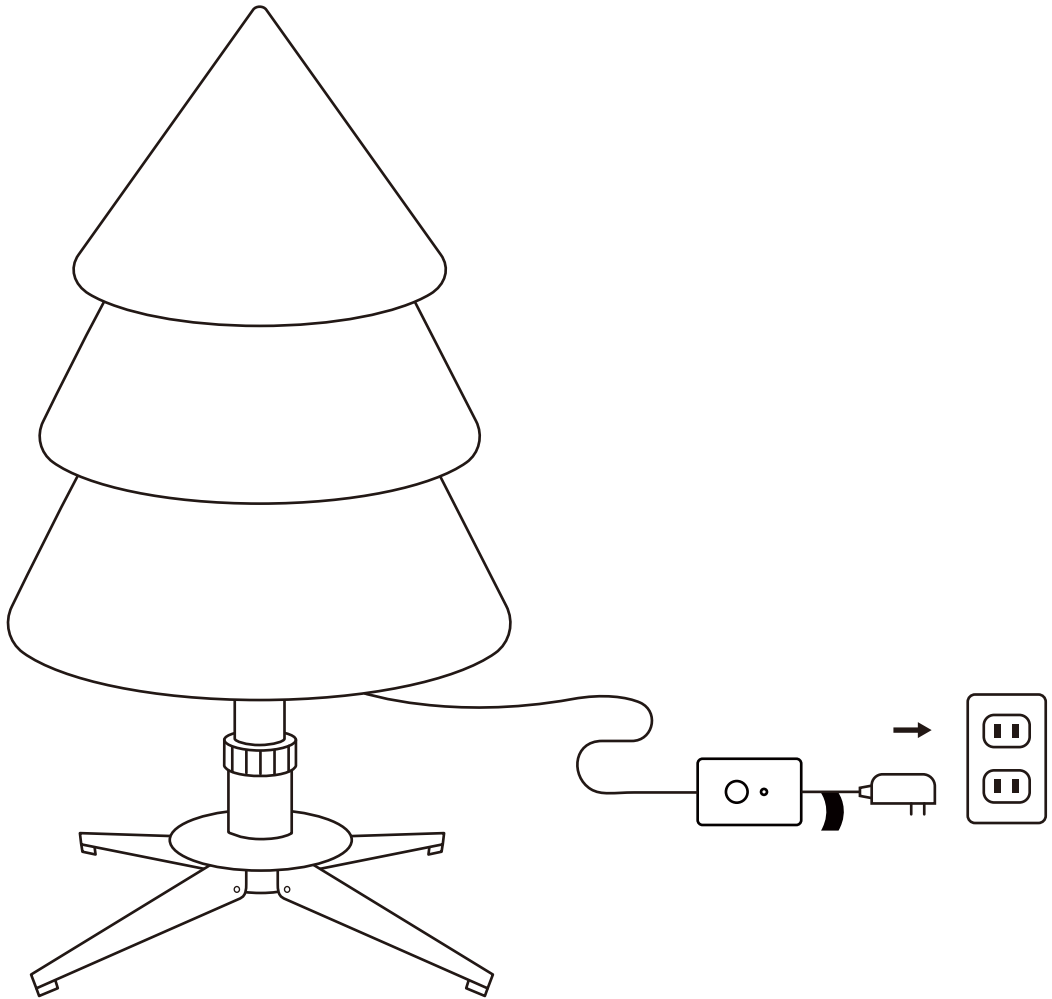

2.

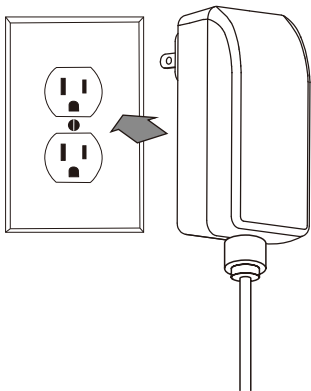

1. Assemble the tree as shown in pictures
2. Plug the power adapter into an AC outlet
3. The tree will illuminate with default effects

3.

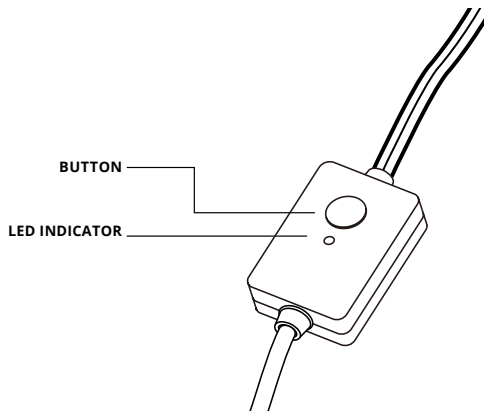

Button: Switch between preset effects/reset

- CONTINUOUS GREEN: AP mode, connected
- FLASHING GREEN: AP mode, no device connected
- CONTINUOUS BLUE: Wi-Fi mode, connected
- FLASHING BLUE: Wi-Fi mode, connection in progress
- FLASHING RED: Wi-Fi mode, unable to connect

-
- GREENISH BLUE: SETUP MODE (Bluetooth ON)
 - YELLOW: Firmware Update in progress
 - CONTINUOUS RED: General error

-
- FLASHING WHITE: Reset procedure in progress

app download

1.



2.

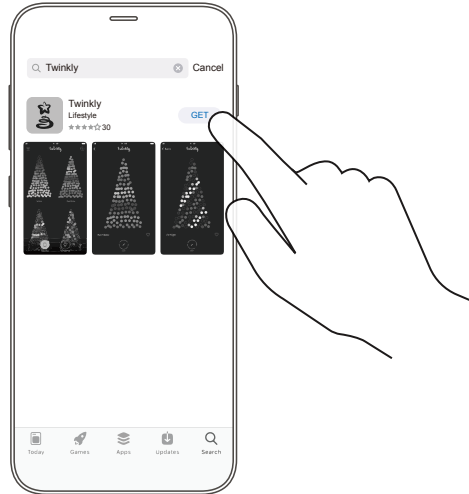

3.

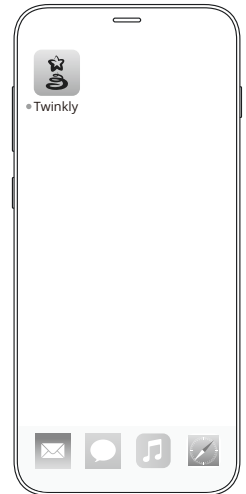

1. Go to App Store/Google Play (by scanning the QR code)
2. Download and install the "Twinky" app
3. Ensure that the Twinky app is correctly installed on your smartphone

set up twinkly

1.

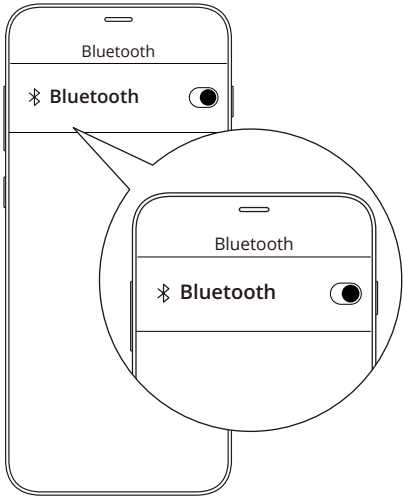

2.

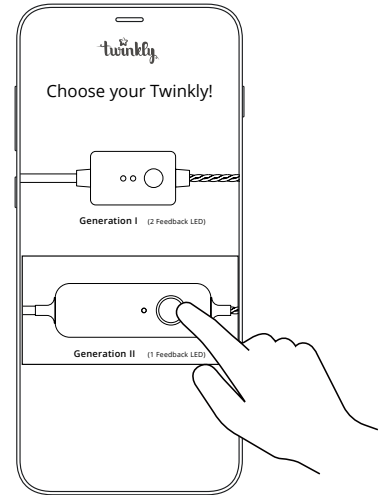
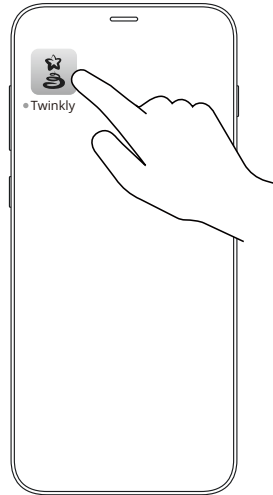

1. Make sure Bluetooth is turned on
2. Open the Twinkly app and select GENERATION II controller for your tree

3.

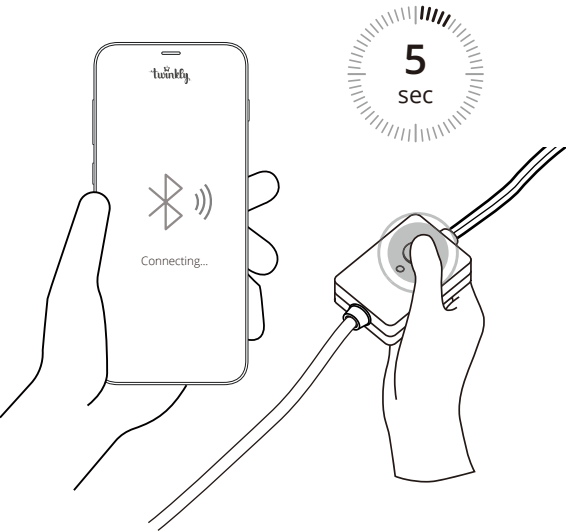

4.

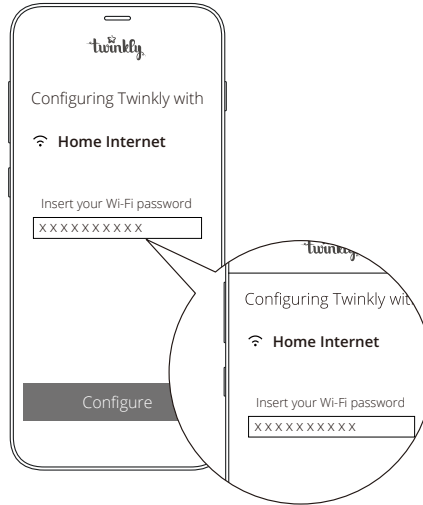

5.

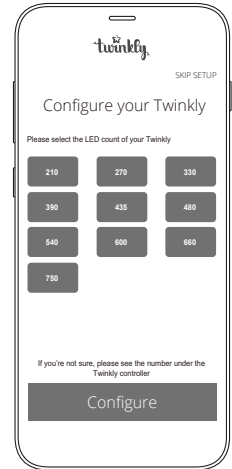

3. Press and hold the controller button until the LED is GREENISH BLUE (approx 5 sec)
4. Select your local Wi-Fi network and enter the password
5. Select the correct light count of your tree and tap "Configure" to complete the connection to your Twinkly tree

If you do not have access to a local Wi-Fi network, connect directly to your smartphone Wi-Fi by following the instructions in the "Troubleshooting" section

mapping

1.

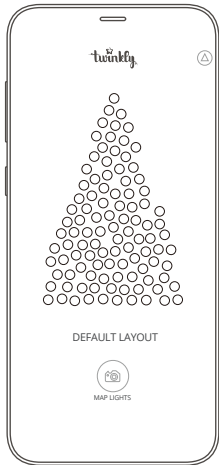

2.

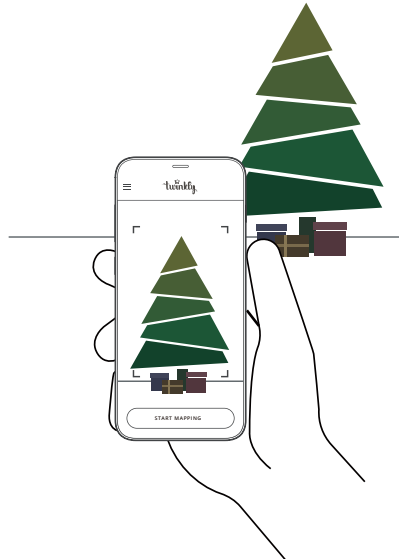

3.



Map the layout of your decoration to unlock the full potential of your Twinkly tree like advanced effects, drawing and many upcoming features.

1. Open Layout and tap the "Map Lights" button
2. Frame the tree from a distance of 1.5-2.5 meters
3. Tap the "Start Mapping" button (all LEDs will illuminate with different RGB colors during the process). Once the process is completed successfully, return to the Effects Gallery to enjoy advanced preset and customizable effects

mapping tips

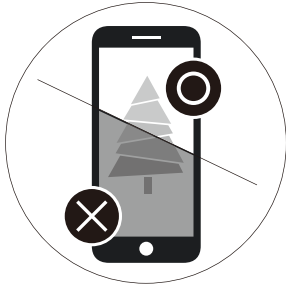
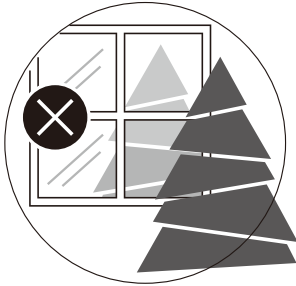

For best results, avoid reflective surfaces behind the tree, keep the mobile cam steady during the process and ensure a moderate ambient light (not too dark)

choose preset effects

1.

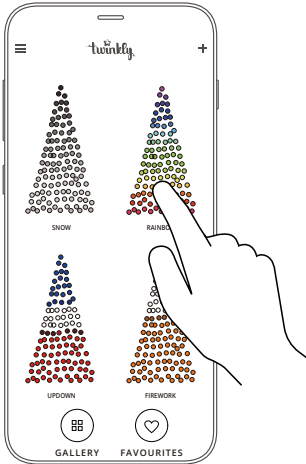

2.

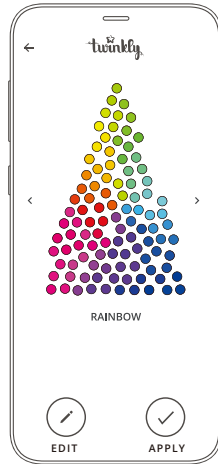

3.

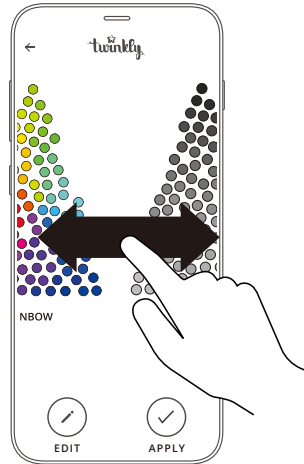

4.

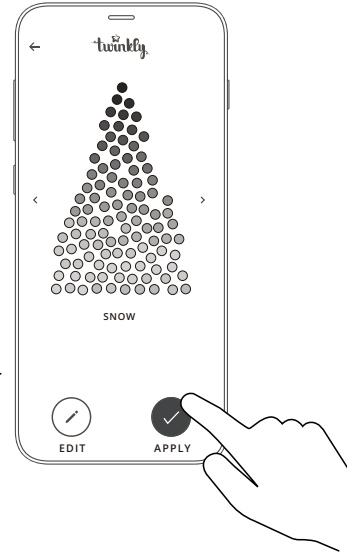

1. Launch the Twinkly app and open the Effects Gallery
2. Select the desired effect to see the real-time preview on your Twinkly set-up
3. Swipe left or right to browse effects
4. Tap "Apply" to store the effect and play continuously

Note: App user interface may change due to technical updates and improvements.

Twinkly comes with 5 preset effects that may be used without downloading the app. Simply plug the tree in and connect the lights to the wall adapter, then push the button on the controller box near the base of the tree. Press the button to continue switching between the 5 preset effects.

advanced features



Connect to local WiFi.
Browse, play and edit effects.



Create new effects.

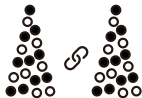

Group multiple devices together.



For all features and more, visit www.twinkl.com/support

troubleshooting

Q LOOSE BRANCH HINGE PIN

- Place the loose branch into the hinge bracket
- Insert an included spare hinge pin through the holes of the bracket
- Secure with an included spare washer

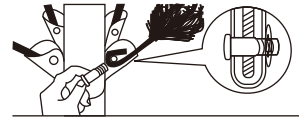

Q THE LIGHTS WILL NOT LIGHT UP

- Check that the light string and adapter are well connected
- Check to make sure that the power adapter is plugged into an outlet and that the controller is correctly connected to your phone
- Check that the green LED of the controller is ON
- Briefly press the button on the controller
- If this does not work, unplug the power adapter from the power outlet, and wait 30 seconds before plugging the power adapter back into the outlet

Q THE LED INDICATOR IS GREENISH BLUE, BUT MY SMARTPHONE CANNOT FIND TWINKLY

- Unplug the power adapter, wait 30 seconds, plug it in again and repeat Configuration procedure
- If this does not work, try to Reset (see Reset procedure on pages 15 -16)
- If this does not work, try moving the tree to another room and/or deactivating other Wi-Fi devices nearby. See online reference manual <http://www.twinkly.com/support>

Q THE LIGHTS ARE ON BUT MOTION EFFECTS ARE FROZEN

- Briefly press the button on the controller
- If this does not work, unplug the power adapter, wait 30 seconds and plug it in again

Q TWINKLY SETUP WAS SUCCESSFUL, BUT THE LIGHTS DON'T RESPOND TO COMMANDS

- Within the Twinkly application, open "Devices" and tap the item circling arrow symbol found in the top right-hand corner of the screen symbol
- If this does not work, stop the Twinkly application and launch it again
- If this does not work, try to Reset (see Reset procedure on pages 15 -16)
- If this does not work, delete the Twinkly application from your smartphone, then download the latest version from App Store or Google Play Store

Q HOW CAN I CONNECT TWINKLY WITHOUT LOCAL WI-FI

- Open Wi-Fi settings on your smartphone
- Find and select "Twinkly_XXXXXX network"
- Enter the Wi-Fi password " Twinkly2019 " and ensure that the "Twinkly_XXXXXX" network is connected

- When resetting your Twinkly using the reset instructions, you will notice the lights start as green when the instructions say they should be red. The green lights will fade to yellow, then orange, before turning red. That is how you know your Twinkly has been properly reset.
- If you are troubleshooting your Twinkly lights and are going through the reset process, you must disconnect from your home Wi-Fi network and reconnect to the "Twinkly_XXXXXX" Wi-Fi network to reconnect to your tree.

reset twinkly

1.

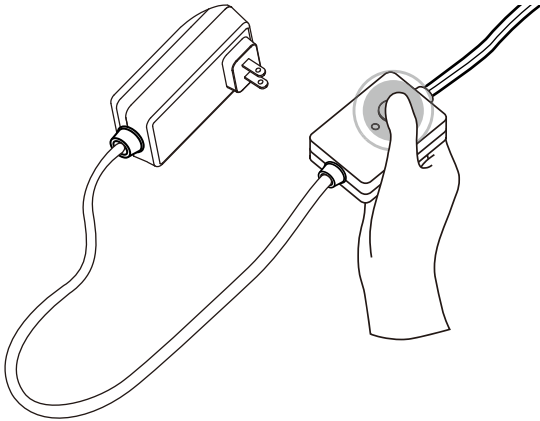

2.

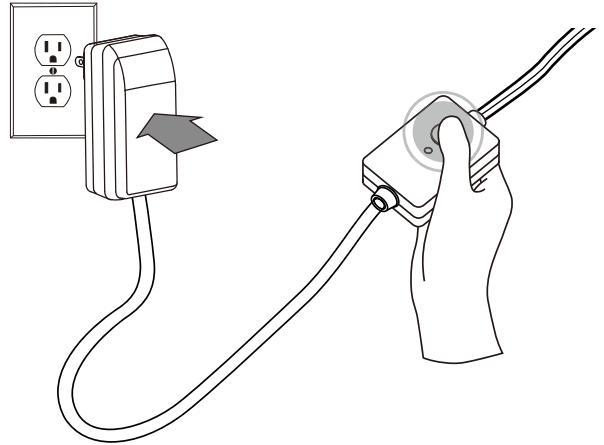

1. Unplug the Twinkly power adapter from the AC outlet. Press and hold the controller button
2. While holding the button, plug in the Twinkly power adapter
3. Keep holding the button until all LED lights on the tree turn red, then release the button

3.

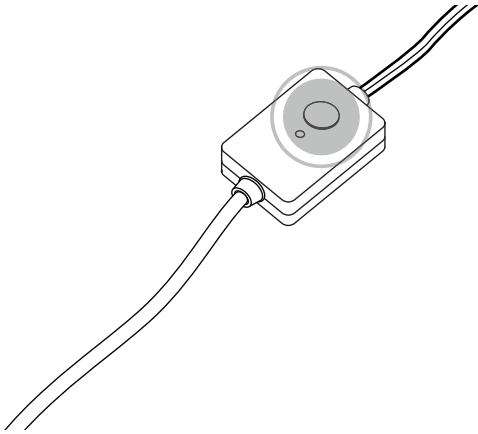

RED

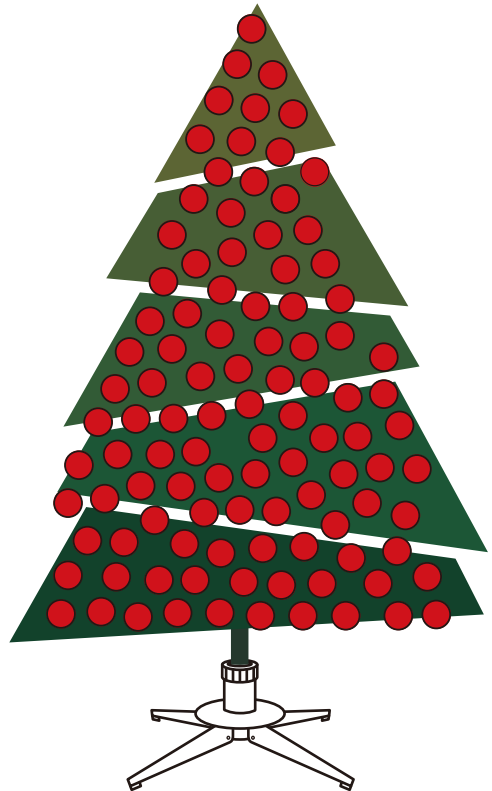

devices storage

1.

2.

3.

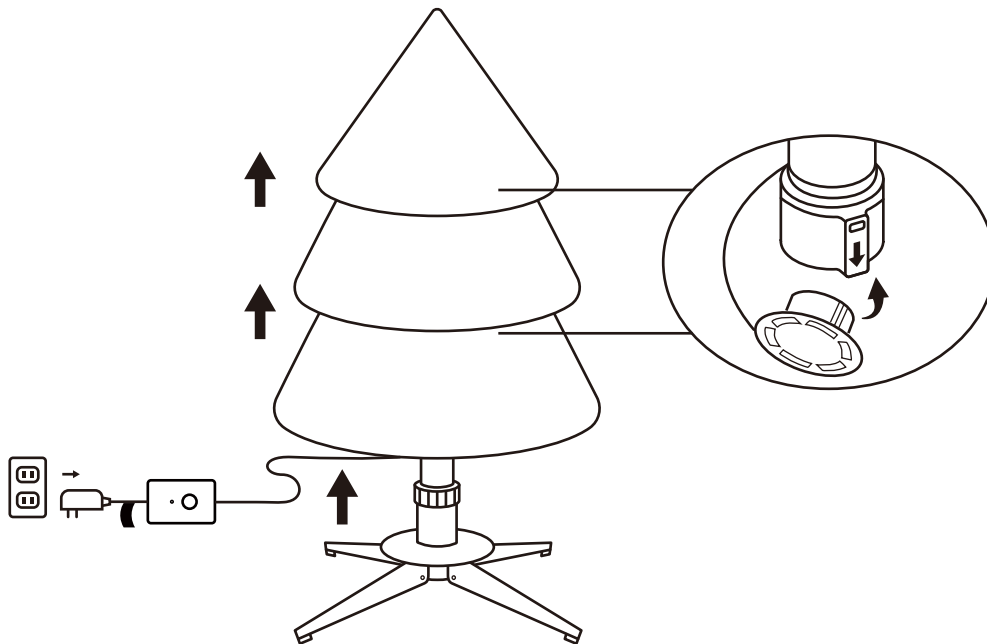

1. Unplug the power adapter from the AC outlet
2. Lift tree poles up gently to disassemble, from top to bottom. Fold all branches towards the pole
3. Close all pole caps
4. Store in a cool, dry place away from sunlight



Polygroup® Trading Limited
Unit 606, 6th Floor, Fairmont House,
No.8 Cotton Tree Drive,
Central, Hong Kong

To know more about your twinkly and its other cool features, please visit:



www.polygroup.com/twinkly